

## **Video Compression and Transmission Strategies in Heterogeneous Network Scenarios** **Miss. Sofia Martinez<sup>1</sup>, Prof. Alejandro Ruiz<sup>2</sup> & Prof. Maria Torres<sup>3</sup>**

<sup>1</sup>Student of MSc Physics, University of Buenos Aires, Buenos Aires, Argentina

<sup>2 & 3</sup>Professors at the Department of Physics, University of Buenos Aires, Buenos Aires, Argentina

---

### **ABSTRACT**

Video may go through different sorts of heterogeneous systems amid the procedure of transmission, which impacts affects the continuous video quality. The previous technique focus on how to compress videos based on the video flow without considering the real-time network information. This system presents an adaptive method that combines video transmission control and video encoding the system over heterogeneous networks. This system includes steps such as : first, to collect and standardize the real-time information describing the network and the video, then to assess the video quality and calculate the video coding rate based on the standardized information, and then to process the encoded compression of the video according to the calculated coding rate and transfer the compressed video. The aim of this project is to provide an adaptive video transmission control system and technique to enhance the ongoing video quality, which takes the continuous system data into the video transmission control over heterogeneous systems. The application-layer protocol has three phases:

- Simultaneously collect video and network flow status
- To adjust the parameters for video quality dynamically that, come from the network and video environment feedback.
- To optimize the video coding rate that is as per the present condition conditions.

**KEYWORDS:** Adaptive, heterogeneous networks, neural networks, video transmission control.

---

### **I. INTRODUCTION**

The current internet faces huge challenges of transmission of real time video. The conventional Internet offers best-exertion correspondence benefits in which the system exchanges the greater part of the messages with its best exertion, without any certifications of the Quality of Service (QoS). Many researchers study on the transfer of real-time video data. The Internet Engineering Task Force (IETF) has proposed several QoS technical solutions, including integrated service, differentiated services, multi-protocol label switching, and traffic engineering. Be that as it may, as the primary QoS issue is dependably the issue of end-to-end transmission, which includes the whole system, changes to one or a couple connections won't take care of the issue. Along these lines, scientists have begun to consider including procedures, for example, retransmission at the application level, to expand the QoS, yet there have been no great outcomes to date. The problem of QoS during the transmission of video process remains unsolved. Test data that have been recorded over a longer period of time may experience several heterogeneous networks that have different physical characteristics, calculation methods, and transmission methods from each other and, therefore, have adverse impacts on the QoS. The video communication network can be classified as Local Area Network (LAN), wireless LAN, intercollegiate network, and the Internet. From the viewpoint of video terminals, we selected parameters representing the features of the network: network time delay, jitter, and packet loss. These parameters are not just illustrative of the external attributes of the whole system; however they are additionally simple to get without respect for the real setup or topology of the system

Fig. 1(a)–(d) shows the delay time distributions for the four types of networks. The time delays of the LAN are approximately 1–2 ms. Most of the time delays of the WLAN are under ten milliseconds, and the majority is approximately 2–3 ms. the variation is much greater than that of the LAN. The time delays of the China Education and Research Network (CERNET) between the Beijing University of Posts & Telecommunications and Tsinghua University are approximately 10 ms and have relatively large variations. The time delays of the Internet are far greater than those of the previous three, concentrated between 180 to 300 m.

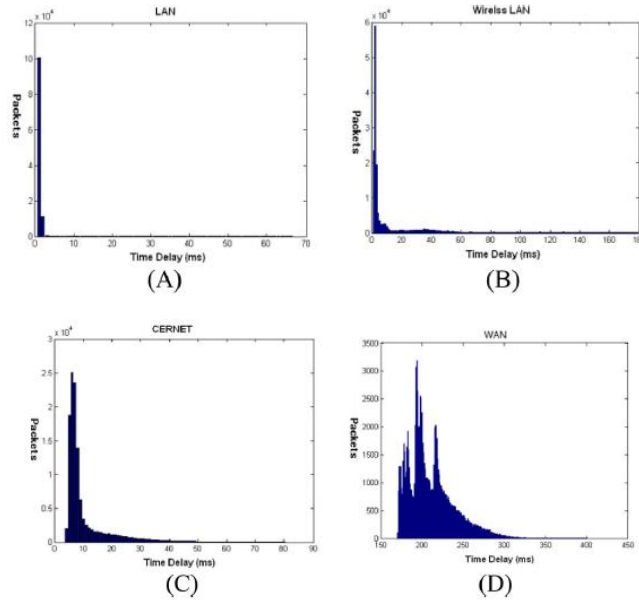

**Fig. 1.** Delay time distributions for different network types.

**A. Adaptive Networks**

Adaptive networks are hardly new. Almost all real world networks are adaptive to some extent. Consequently, examples of adaptive networks occur in many disciplines and can be found in a large number of applied models. What is new, however, is that only over the recent years adaptive networks have come into focus of rigorous investigations that employ simple conceptual models. These investigations have revealed a number of new mechanisms and phenomena: Adaptive networks based on simple local rules can self-organize robustly toward phase transitions and highly non-trivial complex topologies distinct classes of nodes can emerge spontaneously from an initially homogeneous population and, complex dynamics can be observed as a consequence of phase transitions and bifurcations that involve topological as well as local degrees of freedom.

**B. Heterogeneous Network**

Mobile broadband traffic is growing rapidly, driven by the increasing popularity of connected devices, predominantly mobile broadband-enabled smartphones and tablets. What is more, user expectations for mobile broadband are on the rise as people rely more and more on mobile applications, video content, cloud-based services and staying connected anywhere, anytime. Consumers have come to expect a consistent, high-quality and seamless mobile broadband experience wherever they are, including indoors. Meeting these expectations is a key priority for operators looking to differentiate themselves in the Networked Society, in which everything that can benefit from a connection will be connected. To provide the right mobile broadband experience, build customer satisfaction and brand loyalty, and create a platform for new value-added services, especially for enterprise customers, networks need sufficient capacity and coverage to deliver high data throughput with very low latency. One approach is to deploy a heterogeneous network. A heterogeneous network involves a mix of radio technologies and cell types working together seamlessly to deliver the additional capacity, coverage and speed needed to secure excellent user experience. To prepare networks for surging traffic demand, operators need to improve and density their existing mobile broadband networks and add integrated small cells in an optimal way. How, when and where operators migrate to heterogeneous networks will be dictated by their existing networks, their mobile broadband strategies and broader market, technical and economic considerations. One size does not fit all, and flexibility is needed to ensure that subscriber expectations are met in the most cost-effective, spectrum-efficient and future-proof way.

**C. Reinforcement Learning**

Reinforcement learning is learning what to do-how to map situations to actions-so as to maximize a numerical reward signal. The learner is not told which actions to take, as in most forms of machine learning, but instead must discover which actions yield the most reward by trying them. In the most interesting and challenging cases, actions may affect not only the immediate reward but also the next situation and, through that, all subsequent rewards. These two characteristics-trial-and-error search and delayed reward are the two most important distinguishing features of reinforcement learning. Reinforcement learning is defined not by characterizing learning methods, but by characterizing a learning problem. Any method that is well suited to solving that problem, we consider to be a reinforcement learning method. The basic idea of reinforcement learning is simply

to capture the most important aspects of the real problem facing a learning agent interacting with its environment to achieve a goal. Clearly, such an agent must be able to sense the state of the environment to some extent and must be able to take actions that affect the state. The agent also must have a goal or goals relating to the state of the environment. The formulation is intended to include just these three aspects—sensation, action, and goal—in their simplest possible forms without trivializing any of them. Reinforcement learning is different from supervised learning, the kind of learning studied in most current research in machine learning, statistical pattern recognition, and artificial neural networks. Supervised learning is learning from examples provided by a knowledgeable external supervisor.

## II. RELATED WORK

In 2010 S. Ahmad, R. Hamzaoui, and M. Al-Akaidi, Adaptive unicast video streaming with rate less codes and feedback, The majority of studies focus mainly on video compression based on the characteristics of the video, without considering the real-time network status information as time delay, jitter, and packet loss.

S. Soltani, K. Misra, and H. Radha, proposed Delay constraint error control protocol for real-time video communication for the most part concentrate on video compression based on the characteristics of the video, without considering the real-time network status information as time delay, jitter, and packet loss.

In 2014 R. J. Wang, J. T. Fang, Y. T. Jiang, and P. C. Chang, proposed Quantization-distortion models for interlayer predictions in H.264/SVC spatial scalability for the problem of controlling the coding rate.

In 2012 K. K. R. Kambhatla, S. Kumar, S. Paluri, and P. C. Cosman, Wireless H.264 video quality enhancement through optimal prioritized packet fragmentation Discussed the switching of video resources with different coding based on H.264/AVC.

## III. SYSTEM IMPLEMENTATION

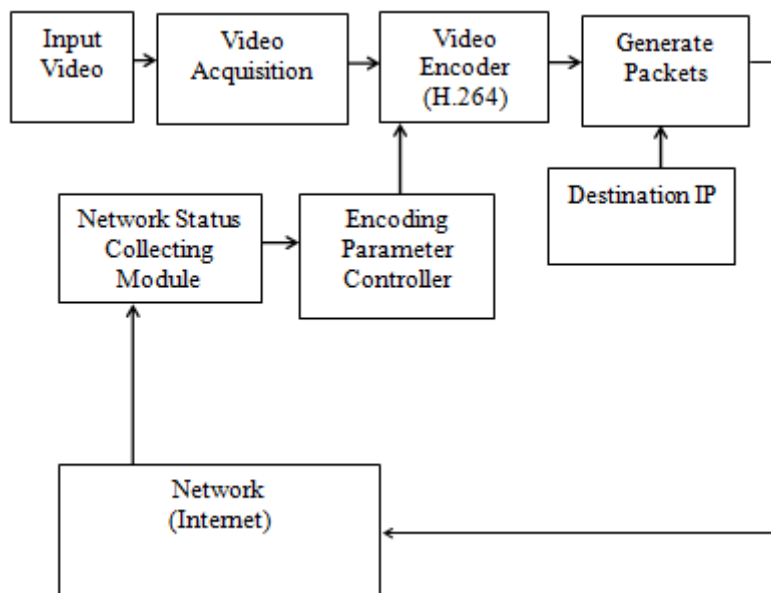

**Fig.2. System Block Diagram**

The implementation of system is as shown in above figure. The role of each and every block is explained below:

- Video is the input to the system which is input to Video acquisition.
- Video Acquisition and Video Encoder then convert that video from analog to digital video format.
- Video Encoder then gives the output in the form of packet we know that a packet is the unit of data that is routed between an origin and a destination on the Internet or any other packet-switched network.
- The packet sent over the network according to the destination IP.
- Provided to Network Status Collecting Module which is responsible to divide video frames into groups, each of which contains two continuous key frames and the frames between, while waiting for the RTCP feedback and calculated the new video coding rate.

### **A. Video Encoder (H.264)**

Video encoders, also known as video servers, enable an existing analog CCTV video surveillance system to be integrated with a network video system. Video encoders play a significant role in installations where many analog cameras are to be maintained.

A video encoder makes it possible for an analog CCTV system to migrate to a network video system. It enables users to gain the benefits of network video without having to discard existing analog equipment such as analog CCTV cameras and coaxial cabling.

The intent of the H.264/AVC project was to create a standard capable of providing good video quality at substantially lower bit rates than previous standards (i.e., half or less the bit rate of MPEG-2, H.263, or MPEG-4 Part 2), without increasing the complexity of design so much that it would be impractical or excessively expensive to implement. An additional goal was to provide enough flexibility to allow the standard to be applied to a wide variety of applications on a wide variety of networks and systems, including low and high bit rates, low and high resolution video, broadcast, DVD storage, RTP/IP packet networks, and ITU-T multimedia telephony systems. H.264/AVC, which is defined by International Organization for Standardization (ISO) and International Telecommunications Union (ITU-T), has relatively high coding efficiency and error resilience. Moreover, the code stream structure has relatively high adaptability and error recovery ability and saves approximately 50% of the coding rate of H.263 with the same picture quality. The application of H.264/AVC to different networks has drawn wide attention. Kim and Hong the configuration problem of applying H.264/AVC to WLAN real-time video, discussed different video coding and network characteristics under different scenarios, and proposed and tested principles for choosing the coding machine and the network parameter configurations.

### **B. Parameter evolutions**

#### **1. Peak signal to noise ratio**

The Peak Signal to Noise Ratio (PSNR) the ratio between maximum possible power and corrupting noise that affect representation of image. PSNR is usually expressed as decibel scale. The PSNR is usually used as measure of quality reconstruction of image. The signal in this case is original data and the noise the error introduced. High estimation of PSNR shows the high quality of image. It is characterized through the Mean Square Error (MSE) and corresponding distortion matrix, the Peak Signal to Noise Ratio.

$$MSE = \sqrt{\frac{\sum |I - I_F|^2}{N \times M}} \quad PSNR = 10 \log_{10} \left( \frac{R^2}{MSE} \right)$$

Here Max is maximum pixel value of image when pixel is represented by using 8 bits per sample. This is 255 bar color image with three RGB value per pixel.

#### **2. Mean Square Error**

Mean square Error is square root of summation between original image and filter image and divides by no of pixel. The formula for mean square error is shown in equation.

### **C. Network Status Collecting Module**

This module is used to collect the condition status information of the network and video flows, which can be realized by monitoring the Real-time Transport Control Protocol (RTCP) flow, and the video condition information can be acquired in the process of video coding . However, there is the problem of information inconsistency in the steps between the two conditions. The network condition information that is received from RTCP feedback is characterized by low frequency, while the video coding is high frequency. We adopted the following strategy to realize the condition-collection module. We divided the video frames into groups, each of which contained one key frame and all of the frames between two key frames, while waiting for the RTCP feedback. The complexity of the frames of the group is defined as the average complexity of all frames in the group, and the SSIM value is defined as the average SSIM values of all frames in the group. All complexity and SSIM information for each group is stored in the condition information buffer for updating. When the RTCP feedback reaches the system, it calculates the video reward value according to the network condition information from the feedback and the SSIM stored. The network condition information collected and the video condition information stored in the condition information is sent to the standardization module for further processing.

#### D. Real-Time Transport Control Protocol (RTCP)

Real-Time Transport Control Protocol (RTCP) is a protocol that works with Real-Time Protocol (RTP) to monitor data delivery on large multicast networks. The purpose of monitoring delivery is to determine whether RTP is providing the necessary Quality of Service (QoS) and to compensate for delays, if needed. RTCP is used in voice over IP (VoIP) and Internet Protocol Television (IPTV), streaming media and video conferencing. RTCP carries statistical and control data, while RTP delivers the data. RTCP statistics typically include the number of bytes sent, packets sent, lost packets and round trip delay between endpoints. RTCP also carries the canonical name (CNAME), which is a unique identifier for a participant during a session. RTCP can use five different packet types to carry statistical and control data. The packets are RR (receiver report), SR (sender report), SDES (source description items), BYE (indicates end of participation) and APP (application specific functions).

#### IV. EXPERIMENTAL RESULT

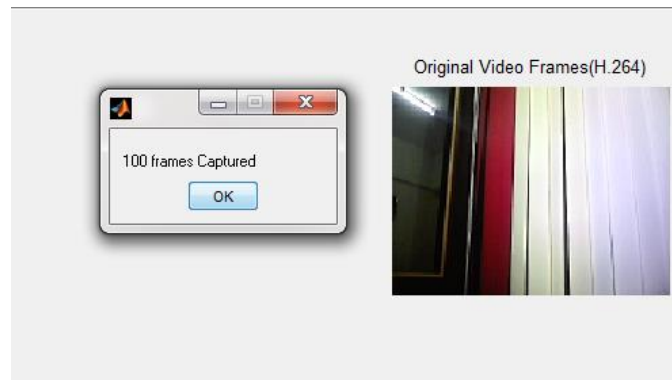

Fig.3.Original Video Frame

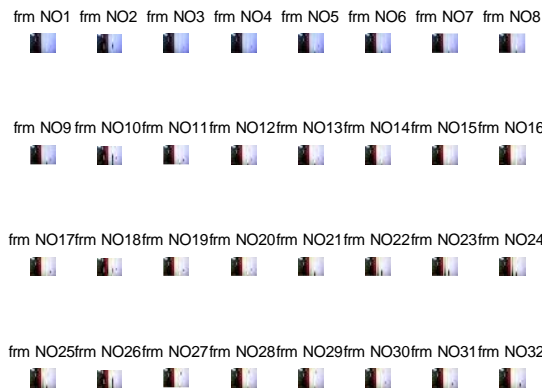

Fig.4.100 Frame Captured

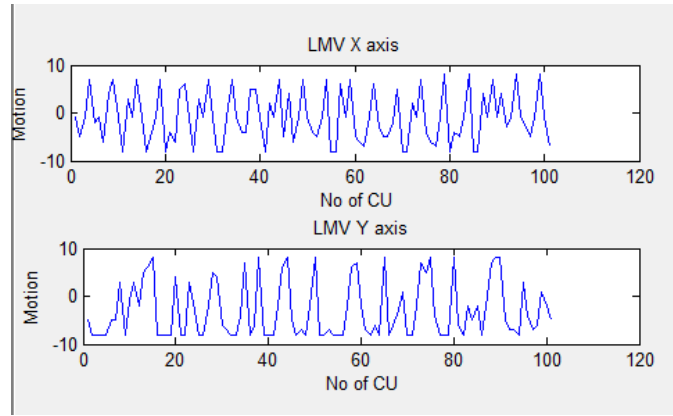

Fig.5. Extract Feature

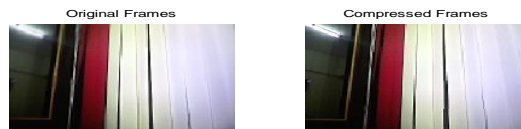

Fig.6. Compare original and compress image

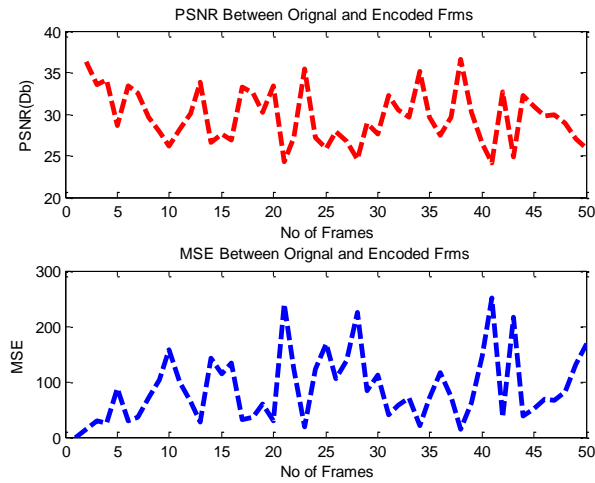

Fig.7. PSNR and MES between original and encoded frames

TABLE I Different Parameters

| Frame Processing rate | Encoded frame Processing rate | Encoded frame Speed up ratio | Encoded frame compression ratio | PSNR    | MSE      |
|-----------------------|-------------------------------|------------------------------|---------------------------------|---------|----------|
| 4.9987                | 17.1937                       | 1.0746                       | 0.93061                         | 25.8635 | 168.5523 |

## V. CONCLUSION

The systems provide an adaptive video transmission control system and methodology to improve the real-time video quality, which takes the real-time network information into the video transmission control over heterogeneous networks. The video is encoding using H.264 method by using parameter learned according to network speed. Combine video bit stream in to Packets with destination IP Address. Transmit packets using TCPIP Protocol over Internet

## VI. ACKNOWLEDGMENT

I have taken efforts in this project. However, it would not have been possible without the kind support and help of My Project guide Prof. Karanjkar M.N. Sir, Prof. Pergad Sir and also our respected Principal Dr. S.M. Jagade Sir and all the staff members of ETC Department of our college. I would like to extend my sincere thanks to all of them. Also am thankful to those authors whose paper I have referred. It would not have been possible without the kind support and help of many individuals and organizations. I would like to extend my sincere thanks to all of them.

## VII. REFERENCES

- [1] H. E. Egilmez, S. Civanlar, and A. M. Tekalp, "An optimization framework for QoS-enabled adaptive video streaming over OpenFlow networks," *IEEE Trans. Multimedia*, vol. 15, no. 3, pp. 710–715, Aug. 2013.
- [2] W. Ji, Z. Li, and Y. Q. Chen, "Joint source-channel coding and optimization for layered video broadcasting to heterogeneous devices," *IEEE Trans. Multimedia*, pp. 443–455, Jun. 2012.
- [3] M. Bystrom and J. W. Modestino, "Combined source-channel coding schemes for video transmission over an additive white Gaussian noise channel," *IEEE J. Sel. Areas Commun.*, vol. 18, no. 6, pp. 880–890, Jun. 2000.
- [4] E. Maani and A. K. Katsaggelos, "Unequal error protection for robust streaming of scalable video over packet lossy networks," *IEEE Trans. Circuits Syst. Video Technol.*, vol. 20, no. 3, pp. 407–416, Mar. 2010.
- [5] S. Ahmad, R. Hamzaoui, and M. Al-Akaidi, "Adaptive unicast video streaming with rateless codes and feedback," *IEEE Trans. Circuits Syst. Video Technol.*, vol. 20, no. 2, pp. 275–285, Feb. 2010.
- [6] E. Dedu, W. Ramadan, and J. Bourgeois, "A taxonomy of the parameters used by decision methods for adaptive video transmission," *Multimedia Tools and Applications*, Nov. 2013, DOI 10.1007/s11042-013-176-6.
- [7] C. Gong and X. Wang, "Adaptive transmission for delay-constrained wireless video," *IEEE Trans. Wireless Commun.*, vol. 13, no. 1, pp. 49–61, Jan. 2014.
- [8] Y. G. Lee and B. C. Song, "An intra-frame rate control algorithm for ultralow delay H.264/advanced video coding (AVC)," *IEEE Trans. Circuits Syst. Video Technol.*, vol. 19, no. 5, pp. 747–752, May 2009.
- [9] H.-P. Shiang and M. van der Schaar, "A quality-centric TCP-friendly congestion control for multimedia transmission," *IEEE Trans. Multimedia*, vol. 14, no. 2, pp. 896–909, Aug. 2012.
- [10] S. Soltani, K. Misra, and H. Radha, "Delay constraint error control protocol for real-time video communication," *IEEE Trans. Multimedia*, vol. 11, no. 4, pp. 742–751, Jun. 2009.
- [11] C. Greco, M. Cagnazzo, and B. Pesquet-Popescu, "Low-latency video streaming with congestion control in mobile ad-hoc networks," *IEEE Trans. Multimedia*, vol. 14, no. 4, pp. 1337–1350, Aug. 2012.
- [12] R. J. Wang, J. T. Fang, Y. T. Jiang, and P. C. Chang, "Quantization-distortion models for interlayer predictions in H.264/SVC spatial scalability," *IEEE Trans. Broadcasting*, vol. 60, no. 2, pp. 413–419, Jun. 2014.
- [13] J. Y. Chen, C. W. Chiu, G. L. Li, and M. J. Chen, "Burst-aware dynamic rate control for H.264/AVC video streaming," *IEEE Trans. Broadcasting*, vol. 57, no. 1, pp. 89–93, Mar. 2011.
- [14] A. Jimenez-Moreno, E. Martinez-Enriquez, and F. Diaz-de-Maria, "Mode decision-based algorithm for complexity control in H.264/AVC," *IEEE Trans. Multimedia*, vol. 15, no. 5, pp. 1094–1109, Aug. 2013.
- [15] J. S. Harsini and M. Zorzi, "Transmission strategy design in cognitive radio systems with primary ARQ control and QoS provisioning," *IEEE Trans. Commun.*, vol. 62, no. 6, pp. 1790–1802, Jun. 2014.
- [16] M.-J. Kim, K.-H. Kim, and M.-C. Hong, "Adaptive rate control in frame-layer for real-time H.264/AVC," in *Proc. ICACT*, 2008, pp. 1875–1880.
- [17] K. K. R. Kambhatla, S. Kumar, S. Paluri, and P. C. Cosman, "Wireless H.264 video quality enhancement through optimal prioritized packet fragmentation," *IEEE Trans. Multimedia*, vol. 14, no. 5, pp. 1480–1495, Oct. 2012.

- [18] Y. M. Hsiao, C. H. Chen, J. F. Lee, and Y. S. Chu, "Designing and implementing a scalable video-streaming system using an adaptive control scheme," *IEEE Trans. Consumer Electron.*, vol. 58, no. 4, pp.1314–1322, Nov. 2012.
- [19] Z. Wang, A. C. Bovik, H. R. Sheikh, and E. P. Simoncelli, "Image quality assessment: From error visibility to structural similarity," *IEEE Trans. Image Process.*, vol. 13, no. 4, pp. 600–612, Apr. 2004.
- [20] L. P. Kaelbling, M. L. Littman, and A. W. Moore, "Reinforcement learning: A survey," *J. Artif. Intelligence Res.*, pp. 237–285, May 1996.
- [21] G. A. Rummery, "Problem solving with reinforcement learning," Ph.D. dissertation, Eng. Dept., Cambridge University, Cambridge, U.K., 1995